

Living up to Life

Leica
MICROSYSTEMS



Leica DM500 & DM750

A New Generation's Choice of Innovative Educational Microscopes

Made for Future Nobel Prize Winners

Science Teaching Revitalized

The more time the instructor has to teach, the more students can learn. The Leica DM500 and Leica DM750 microscopes were specifically developed to revitalize science teaching and to achieve the goal of more hands-on time for Life Science courses. With many student-friendly features and high-quality construction, the Leica DM500 and Leica DM750 invigorate science learning and teach the next generation of scientists effectively and efficiently.

SUPERB OPTICS

- › Based on the same optical platform as Leica Microsystems' research microscope line, students enjoy outstanding optical performance with full access to virtually all accessories from Leica's microscope product line.
- › NEW! 100× dry (no oil needed) objective provides very high resolution (N.A. 0.8) while eliminating the need for oil.

EZLITE™

- › LED illumination provides cool, white light with a lifetime of over 20 years average use. There is no need to change lamps during lab time, and this saves the expense of replacement lamps as well.
- › The cost-savings pays for several microscopes over their lifetimes.

SAFETSTAGE™

- › Microscope stage maintains its dimension, which eliminates the chance of injury from contact with a conventional stage rack.
- › Rounded edges are easy on the skin.

EZSTORE™

- › Integrated vertical handle provides easy carrying and lifting when storing on high shelves; undercut on front of stand works in combination with the handle for safer, two-handed carrying.
- › Integrated cord wrap eliminates damage to microscope components from improper cord wrapping; vertical cord insertion prevents the cord from pulling partially out of the stand while in storage or in use.
- › The unique shape of the microscope stand protects controls from damage when microscopes are stored side-by-side.

EZGUIDE™

- › Student friendly slide holder helps prevent slide chipping

USB POWER CONNECTOR

- › Providing power to the Leica USB cameras is extremely easy. Simply connect the camera via the provided USB cable to the 5 V/1.5 A USB power connector on the rear of the Leica DM500 and Leica DM750 stand. This saves the cost of an external power supply for the camera plus reduces the complexity at the workstation.

AGTREAT™

- › The possible contamination with germs from surfaces is of great concern, especially in educational environments. Leica Microsystems has integrated an additive to the material of all microscope touchpoints to inhibit the growth of bacteria. This helps prevent the spread of disease via the microscope surfaces and leads to a healthier laboratory environment.



Leica DM500 – Science Teaching Made Easy

The Leica DM500 is ideal for entry level Life Science courses. The microscope's stand provides "plug and play" capability. All students need to do is turn the power on, place the specimen slide on the stage, focus, and enjoy the view!



READY TO WORK

- › Pre-centered, pre-focused Abbe condenser eliminates the need for adjustments



EZTUBE™

- › Eyepieces integrated with the eyetubes prevents loss
- › Preset diopter adjustments eliminates the risk of incorrectly setting the diopters
- › Other viewing tubes are also available



SAFER ROTATION

- › Captive thumbscrew for safer rotation of the EZTube™



ALL IN ONE

- › Abbe Condenser with slot for phase contrast and darkfield sliders, including a 4 position phase slider, which offers brightfield and phase capabilities all in one slider



PERFECT LIGHT

- › LED illumination designed to provide even lighting across the full field of view without adjustments

Leica DM750 – Science Teaching for a New Generation

The Leica DM750 is designed specifically for the versatile needs of advanced Life Science courses and for professional training such as medical, veterinary, and dental schools.

VERSATILE

- › Standard condenser for magnifications 4× – 100×
- › Phase turret condenser for brightfield and phase contrast
- › Flip top condenser for low magnifications
- › The Leica DM750 is available with a 4 position or 5 position nosepiece



WEAR RESISTANT

- › Special stage finish offers additional protection from friction damage



ENERGY SAVING

- › Time delay shutoff saves energy by automatically turning off the illumination after 2 hours of no use



A+ FOCUS, CONTRAST & ILLUMINATION

- › Weighted focus knobs provide inertia and extremely accurate focus capability
- › Koehler field diaphragm available as an option for optimum illumination and contrast



SHARED VIEWING MADE EASY

- › Variety of viewing tubes provides free rotation while securely fixed to the stand
- › Standard viewing tubes with eyepiece locking screws prevent loss of eyepieces



Go Wireless!

The ability to share, capture, and archive images is an important part of the microscopy laboratory. The Leica DM500 and Leica DM750 are compatible with the full range of Leica Microsystems imaging solutions, allowing you to select the camera which best suits the demands of your classroom. Keep students on topic and maximize learning time with the NEW Leica ICC50 W High Definition Wireless camera module.

LEICA ICC50 W CAMERA MODULE – INTEGRATED AND MODULAR

- › WiFi mode to wirelessly broadcast an HD image directly to your mobile device for independent annotation and image capture by several students
- › Download the Leica AirLab app for camera setup, annotations, measuring, image capture, and sharing to email, photo folders, or other social media connections
- › USB mode to connect directly by cable to your PC for fastest live image of moving objects
- › The ICC50 W is compatible with the full range of Leica imaging software modules for versatility.
- › Ethernet mode to connect to your own network and allow for the maximum number of mobile devices to access the image
- › SD mode to capture directly onto a memory card when mobile devices and PC's are not available
- › Always connect to an HD display for maximum flexibility
- › Handheld remote for convenient fine tuning of camera settings, capturing onto the SD card, and viewing the gallery of images saved on the SD card
- › The Leica ICC50 W can be powered directly from the Leica DM500 or Leica DM750 stands minimizing infrastructure and cost. Power by external power supply or PC is also possible.
- › Modular design allows for easy upgrades and service

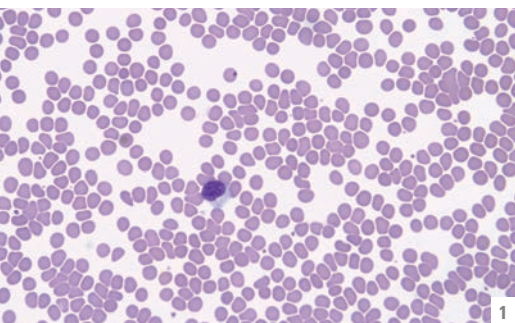

1

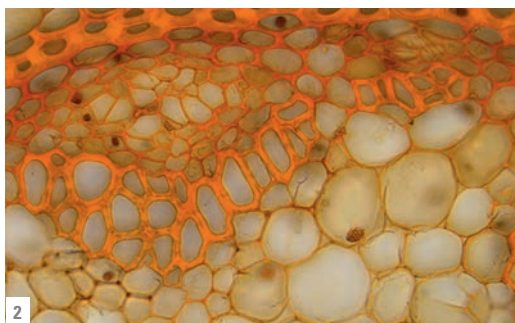

2



3

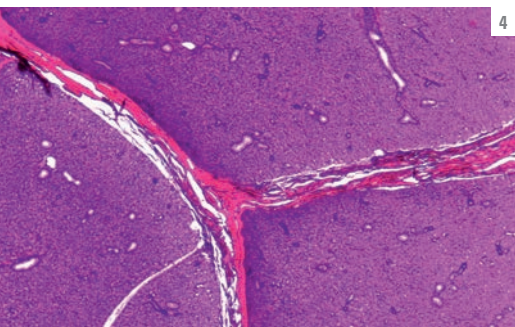

4

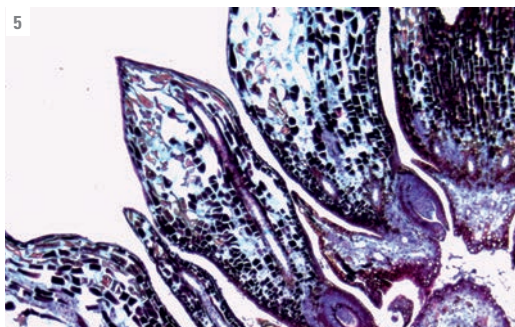

5

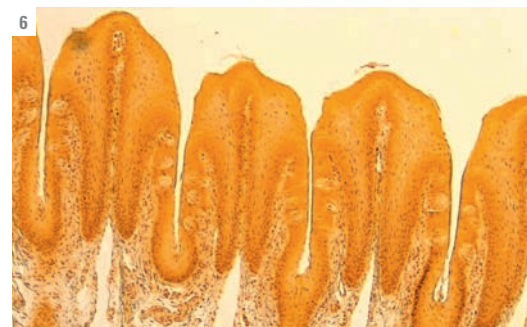

6



- 1: Human Blood
- 2: Convallaria – Lily of the Valley
- 3: Giant Chromosomes
- 4: Parotid Gland
- 5: Pine
- 6: Taste Buds

Leica DM750 with Leica ICC50 W digital microscope camera



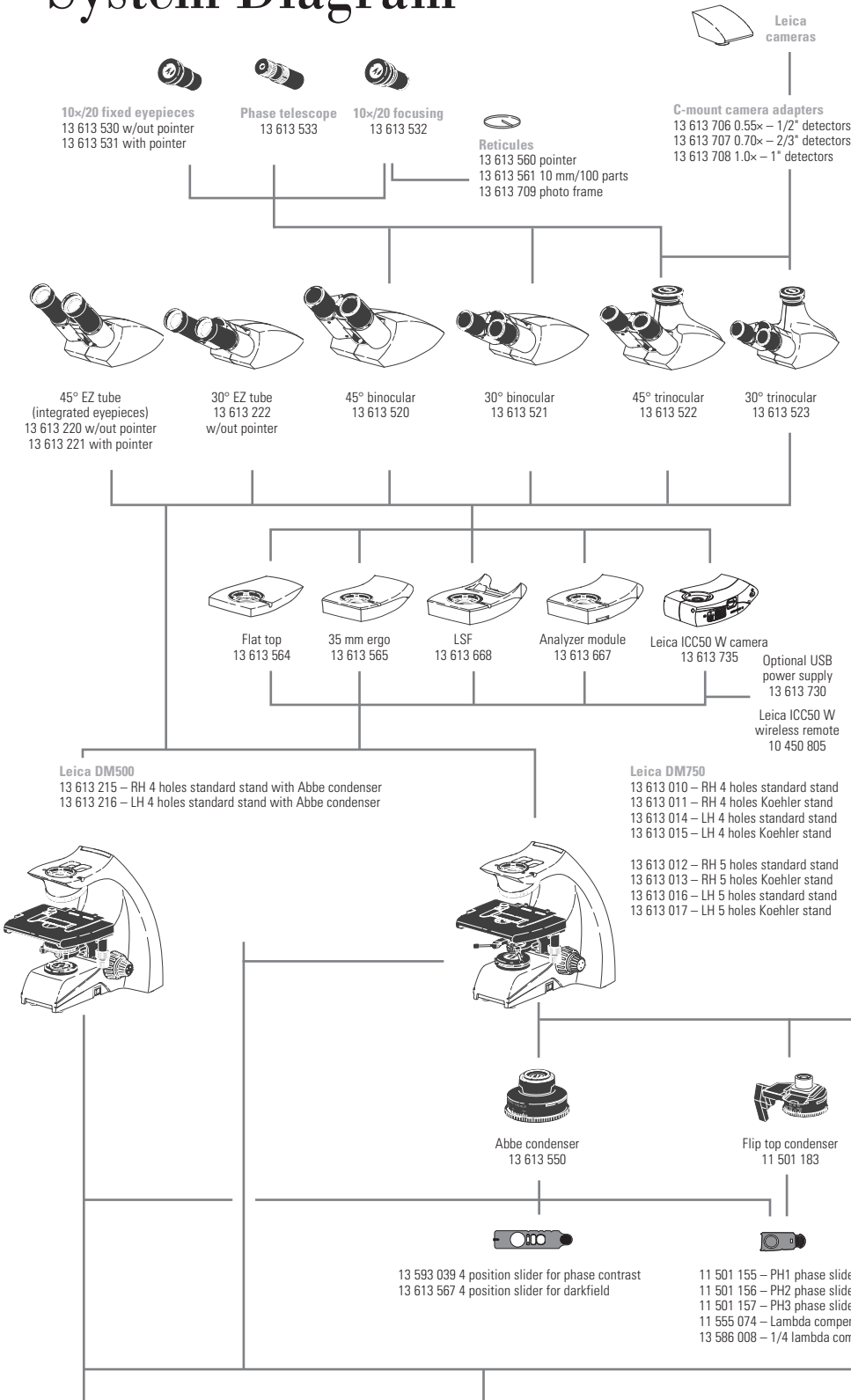



System Diagram



- Replacements**
- 13 613 563 Eyeguard pair
 - 13 RFAG30003 Fuses for Leica DM500, Leica DM750
 - 13 613 571 Thumbscrew pair for Leica DM750 condenser mount
 - 13 613 572 Set screw pair for Leica DM750 condenser mount
 - 13 613 584 Dust cover Leica DM500, Leica DM750
 - 13 613 210-100 Leica DM500 User documents
 - 13 613 510-100 Leica DM750 User documents
 - 13 613 735-100 Leica ICC50 W user documents
 - 13 613 573 Add-on lens for condensers for Leica DM750 (included with stand)

- Analyzer module sliders**
- 11 555 045 Fixed analyzer slider
 - 11 555 079 180° rotatable analyzer slider
 - 11 555 080 360° rotatable analyzer slider

- Others**
- 13 613 262 Captive thumbscrew for EZ tube
 - 13 613 261 Rubber grips for X/Y controls
 - 13 614 800 Immersion oil
 - 11 513 106 Stage micrometer
 - 11 505 091 Diffuser slider for using 2.5x objective with Abbe condenser
 - 11 505 507 Auxilliary lens for using 2.5x objective with 11 501 183 flip top condenser
 - 13 613 566 32 mm filter holder
 - 13 613 263 Hard carrying case
 - 10 450 245 Soft carrying case
 - 13 613 562 Simple pol kit

- International power cords**
- 13 613 900 U.S. 
 - 13 613 901 Europe Continental 
 - 13 613 902 U.K. 
 - 13 613 903 Switzerland 
 - 13 613 904 Denmark 
 - 13 613 905 Italy 
 - 13 613 906 Australia 
 - 13 613 907 China 
 - 13 613 908 Japan 
 - 13 613 909 Israel 
 - 13 613 910 South Africa 
 - 13 613 911 India 
 - 13 613 912 Argentina 

- Plan FOV 18 objectives**
- 13 613 240 - Plan 4x/0.10 NA, 26.2 mm*
 - 13 613 241 - Plan 10x/0.22 NA, 7.8 mm*
 - 13 613 242 - Plan 40x/0.65 NA, 0.31 mm*
 - 13 613 243 - Plan 100x/1.25 NA, 0.10 mm*, oil
- * working distance

- HI Plan FOV 20 objectives**
- 11 506 226 - HI Plan 4x/0.10 NA, 18.0 mm*
 - 11 506 228 - HI Plan 10x/0.25 NA, 12.0 mm*
 - 11 506 276 - HI Plan 20x/0.40 NA, 0.92 mm*
 - 11 506 236 - HI Plan 40x/0.65 NA, 0.36 mm*
 - 11 506 237 - HI Plan 63x/0.75 NA, 0.31 mm*
 - 11 506 238 - HI Plan 100x/1.25 NA, 0.10 mm*, oil
 - 11 506 322 - HI Plan 100x/0.80 NA, 0.3 mm* dry objective
- * working distance

- HI Plan phase FOV 20 objectives**
- 11 506 230 - HI Plan phase 10x/0.25 NA, 12.0 mm*
 - 11 506 278 - HI Plan phase 20x/0.40 NA, 0.92 mm*
 - 11 506 240 - HI Plan phase 40x/0.65 NA, 0.36 mm*
 - 11 506 241 - HI Plan phase 100x/1.25 NA, 0.10 mm*, oil
- * working distance

Preconfigured Outfits

OUTFIT ORDERING NUMBER	13 613 205	13 613 206	13 613 006	13 613 003	13 613 001	13 613 004	13 613 002	13 613 005
	DM500	DM500	DM750	DM750	DM750	DM750	DM750	DM750
STANDS								
13 613 215	DM500 RH Stand with Abbe condenser	X	X					
13 613 010	DM750 RH Stand			X	X	X	X	
13 613 011	DM750 RH Stand Koehler						X	X
TUBES								
13 613 220	45° EZ tube	X	X					
13 613 221	45° EZ tube with pointer		X		X			
13 613 520	45° binocular tube					X	X	X
EYEPIECES								
13 613 530	10×/20 eyepiece w/eyeguard					X	X	
13 613 531	10×/20 pointer eyepiece w/eyeguard					X		X
13 613 532	10×/20 focusing eyepiece w/eyeguard					X	X	X
CONDENSERS								
13 613 550	Abbe condenser 0.9 Dry/1.25 oil			X	X	X	X	X
OBJECTIVES								
13 613 240	Plan 4×/0.10 NA, 26.2 mm W.D.	X	X	X	X			
13 613 241	Plan 10×/0.22 NA, 7.8 mm W.D.	X	X	X	X			
13 613 242	Plan 40×/0.65 NA, 0.31 mm W.D.	X	X	X	X			
13 613 243	Plan 100×/1.25 NA, 0.10 mm W.D., oil	X	X	X	X			
11 506 226	HI Plan 4×/0.10 NA, 18.0 mm W.D.					X	X	X
11 506 228	HI Plan 10×/0.25 NA, 12.0 mm W.D.					X	X	X
11 506 236	HI Plan 40×/0.65 NA, 0.36 mm W.D.					X	X	X
11 506 238	HI Plan 100×/1.25 NA, 0.10 mm W.D., oil					X	X	X
13 614 800	Immersion oil	X	X	X	X	X	X	X

POWER CORD NOT INCLUDED: Must be ordered separately

Dimensions Leica DM500 / DM750

Dimensions in mm/inch

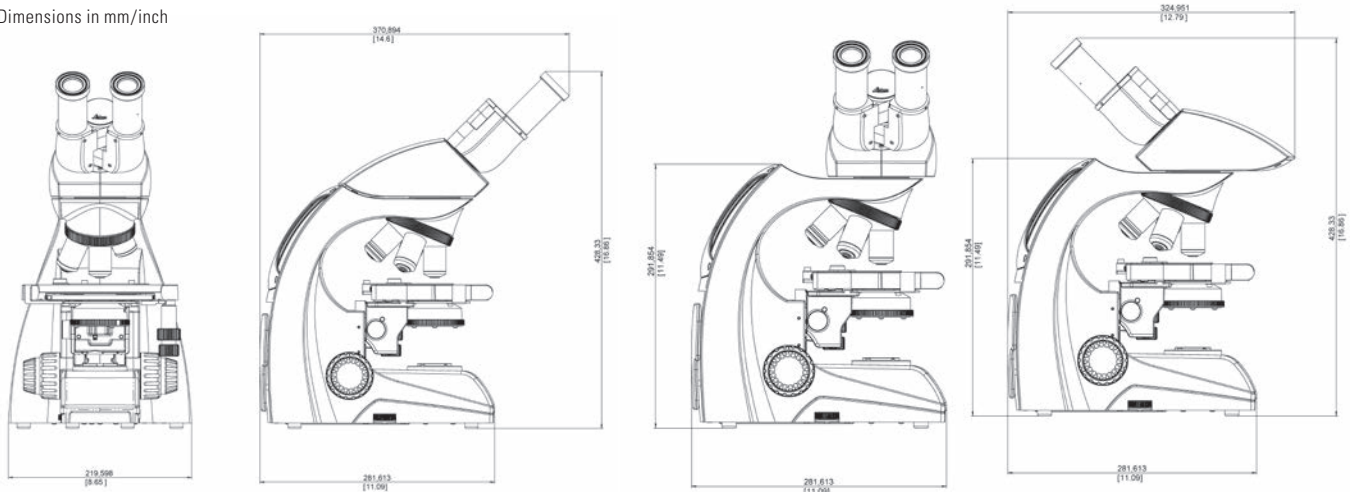

Specifications Leica DM500 / DM750

	DM500	DM750		DM500	DM750
SEPARATE EYEPIECES			SAFETSTAGE™		
High eyepoint	X	X	Stage surface 185 mm (150 mm front) wide × 140 mm deep	X	X
10×/20 (20 mm field of view)	X	X	Rounded stage edges	X	X
Available with or without pointer	X	X	Non extending rack	X	X
Available fixed or focusing	X	X	Verniers for X/Y coordinates	X	X
Focusing eyepieces with reticule holder for 24.5 mm reticle	X	X	Wear resistant stage surface	X	X
Foldable eyeguards	X	X	CONDENSER		
30 mm mounting diameter	X	X	Prefocused and precentered Abbe condenser	X	
EZTUBE™			Centerable and focusable condenser mount		X
Preset diopters for corrected vision	X	X	Slot in Abbe condenser for contrast sliders (phase, darkfield, compensator)	X	X
45 degree viewing angle	X	X	Magnification labels on condenser	X	X
10×/18 (18 mm field of view)	X	X	Standard Leica condenser mount for condensers (Abbe, turret, flip top, etc.)		X
Attaches to stand with set screw	X	X	FOCUS		
Captive thumbscrew available for safer rotation	X	X	Low position focus controls	X	X
Eyepieces are integrated with tube	X	X	Self adjusting focus mechanism	X	X
Available with pointer and without pointer	X	X	300 microns per fine focus rotation	X	X
Interpupillary distance range 52 mm – 75 mm	X	X	Calibrated in 3 micron increments	X	X
OTHER VIEWING TUBES FOR SEPARATE EYEPIECES			Weighted focus knobs		X
45 degree, 30 degree, trinocular	X	X	EZLITE™		
Maximum field of view 20 mm	X	X	Preset field aperture only	X	
Rotatable dovetail	X	X	Available with or without adjustable Koehler field diaphragm		X
Leica tube dovetail standard	X	X	LED Illumination – 6 000 K temp, 25 000 h life at full intensity	X	X
Eyepiece locking screw	X	X	Continuous intensity adjustment	X	X
Interpupillary distance range 52 mm – 75 mm	X	X	Illumination sufficient for viewing at lowest intensity	X	X
STAND			Simple polarizing kit available	X	X
Stand shape protects controls	X	X	2 hour Auto Off (can be disabled or enabled)		X
Stand construction – die-cast aluminium	X	X	Auto Off default: 4 hole stands enabled, 5 hole stands disabled		X
External fuses	X	X	IMAGING		
Knurled nosepiece	X	X	Trinocular tubes available (50 %/50 % light split)	X	X
4 position nosepiece only	X		C-mount adapters with standard Leica mount	X	X
4 or 5 position nosepiece available		X	Leica ICC50 W intermediate camera module (50 %/50 % light split)	X	X
Drop in holder for 32 mm mounted or unmounted filters	X	X	INTERMEDIATE MODULES		
5 V/1.5 A USB power supply to power camera	X	X	35 mm intermediate ergo module available	X	X
EZSTORE™			15 mm flat top module	X	X
Vertical handle	X	X	Module for LSF reflected light illuminator	X	X
Undercut in front of stand	X	X	Analyzer module	X	X
Cord wrap	X	X	AGTREAT™		
Vertical cord attachment to stand	X	X	Anti microbial treatment	X	X
OBJECTIVES			CERTIFICATIONS		
Infinity optics platform	X	X	cULus, CE, RoHS	X	X
Plan optics for FOV 18	X	X	Main optical components meet ISO 9022-11 for Mould Growth	X	X
HI Plan for FOV 20	X	X	SHIPPING		
100× dry objective with N.A. 0.8 (no correction collar)	X	X	Dimensions: 40 cm × 37 cm × 39 cm (H×D×W)	X	X
Objective labeling laser engraved (HI Plans)	X	X	Weight: 9 kg	X	X
M25 nosepiece thread	X	X	EZGUIDE™		
One-handed slide loading			One-handed slide loading	X	X
26 mm × 76 mm stage travel			26 mm × 76 mm stage travel	X	X

Clean and Green

WE ACTIVELY IMPLEMENT WAYS TO MAKE OUR ENVIRONMENT CLEANER AND SAFER FOR THIS GENERATION AND THE NEXT

- › All packaging is completely recyclable
- › No lead content in any of the glass components
- › LED illumination consumes approximately 80 % less energy than standard halogen illumination
- › The time delay shut-off feature found on the Leica DM750 ensures no energy is wasted
- › Constantly optimizing our logistics chain keeps the CO₂ footprint as low as possible
- › AgTreat™ helps prevent the spread of disease via microscope surfaces and leads to a healthier laboratory environment
- › All products have been tested by independent safety laboratories and carry the cULus and CE mark to indicate their design for safety
- › All products are RoHs compliant, which means all electrical components meet restrictions on the use of hazardous substances

SEE MORE AT WWW.LEICA-MICROSYSTEMS.COM/EDUCATION

- › Interactive tour of the Leica DM500 and Leica DM750
- › Leica E-Series stereomicroscopes for low magnification inspection, dissecting, and image capture
- › Leica DM750 P Polarizing Microscope for Earth and Materials Science education
- › Leica DM750 M Microscope for Metallography
- › Selection of higher level microscopes for research
- › A selection of instructional booklets, which are free of charge



The statement by Ernst Leitz in 1907, “*With the User, For the User,*” describes the fruitful collaboration with end users and driving force of innovation at Leica Microsystems. We have developed five brand values to live up to this tradition: Pioneering, High-end Quality, Team Spirit, Dedication to Science, and Continuous Improvement. For us, living up to these values means: **Living up to Life.**

Leica Microsystems operates globally in three divisions, where we rank with the market leaders.

LIFE SCIENCE DIVISION

The Leica Microsystems Life Science Division supports the imaging needs of the scientific community with advanced innovation and technical expertise for the visualization, measurement, and analysis of microstructures. Our strong focus on understanding scientific applications puts Leica Microsystems’ customers at the leading edge of science.

INDUSTRY DIVISION

The Leica Microsystems Industry Division’s focus is to support customers’ pursuit of the highest quality end result. Leica Microsystems provide the best and most innovative imaging systems to see, measure, and analyze the microstructures in routine and research industrial applications, materials science, quality control, forensic science investigation, and educational applications.

MEDICAL DIVISION

The Leica Microsystems Medical Division’s focus is to partner with and support surgeons and their care of patients with the highest-quality, most innovative surgical microscope technology today and into the future.

Leica Microsystems – an international company with a strong network of worldwide customer services:

Active worldwide		Tel.	Fax
Australia · North Ryde	+61	2 8870 3500	2 9878 1055
Austria · Vienna	+43	1 486 80 50 0	1 486 80 50 30
Belgium · Diegem	+32	2 790 98 50	2 790 98 68
Brazil · São Paulo	+55	11 2764-2411	11 2764-2400
Canada · Concord/Ontario	+1	800 248 0123	847 405 0164
Denmark · Ballerup	+45	4454 0101	4454 0111
France · Nanterre Cedex	+33	811 000 664	1 56 05 23 23
Germany · Wetzlar	+49	64 41 29 40 00	64 41 29 41 55
India · Mumbai	+91	226 1880 200	226 1880 333
Italy · Milan	+39	02 574 861	02 574 03392
Japan · Tokyo	+81	3 5421 2800	3 5421 2896
Korea · Seoul	+82	2 514 65 43	2 514 65 48
Netherlands · Rijswijk	+31	70 4132 100	70 4132 109
People’s Rep. of China · Hong Kong	+852	2564 6699	2564 4163
· Shanghai	+86	21 6039 6000	21 6387 6698
Portugal · Lisbon	+351	21 388 9112	21 385 4668
Singapore	+65	6550 5999	6564 5955
Spain · Barcelona	+34	93 494 95 30	93 494 95 32
Sweden · Kista	+46	8 625 45 45	8 625 45 10
Switzerland · Heerbrugg	+41	71 726 34 34	71 726 34 44
United Kingdom · Milton Keynes	+44	800 298 2344	1908 577640
USA · Buffalo Grove/Illinois	+1	800 248 0123	847 405 0164